

NOTE:

Controller P/N	R3	R5	NC
85/87/87T/89L/86T/90/90T/98L	330ohm	3.3ohm	
AU6989/AU6998	330ohm	2.2ohm	
89NL/89N/98NL/98N	680ohm	3.3ohm	C1, C2, R1, Y1

∴ Don't Support AU6981/82/83.

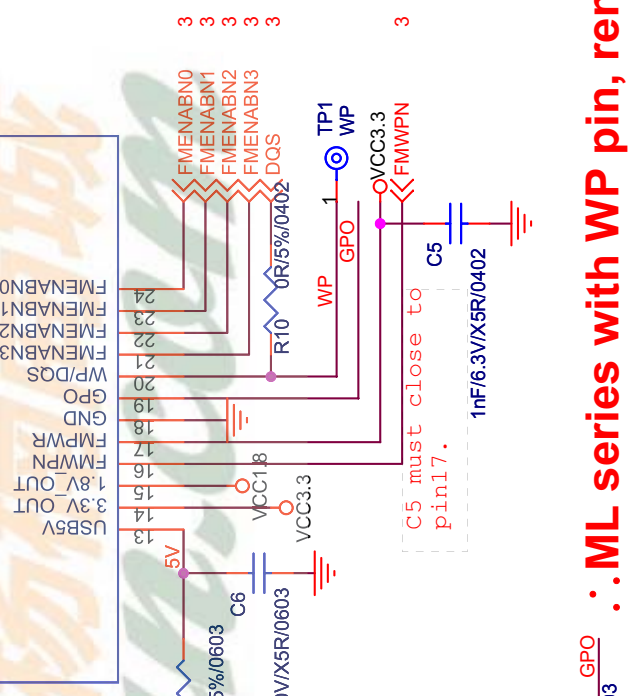
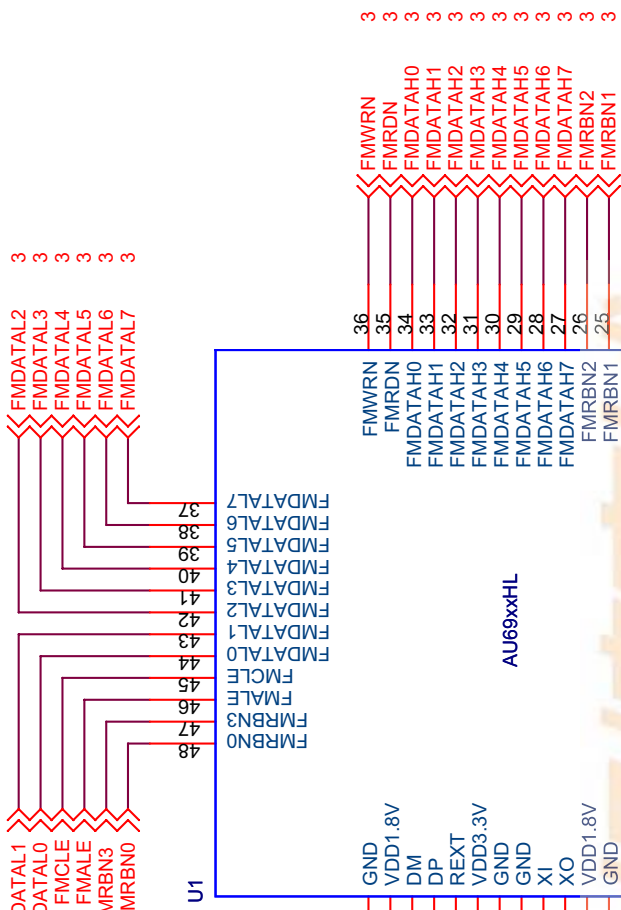
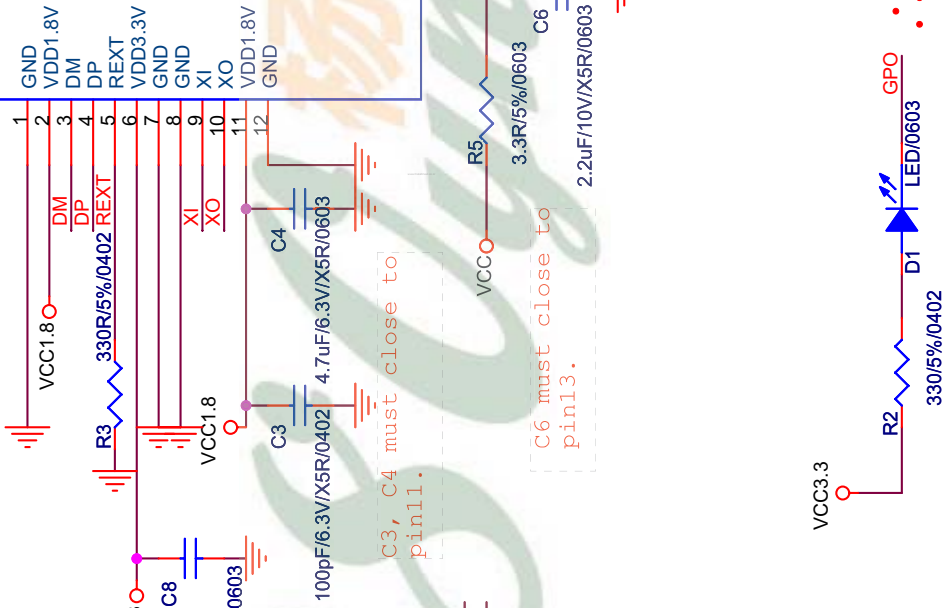
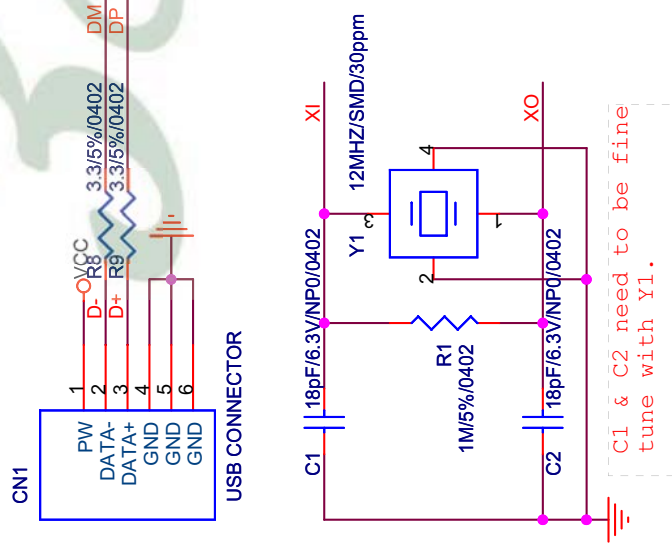

C1 & C2 need to be fine tune with Y1.

C3, C4 must close to pin11.

C6 must close to pin13.

C5 must close to pin17.

Alcor Micro Corp.
 Title: AU69XX GH1
 Document Number: AU69XX GH1
 Date: Wednesday, May 18, 2011
 Sheet 2 of 4
 Rev 1.6.2.2

∴ ML series with WP pin, remove R10.

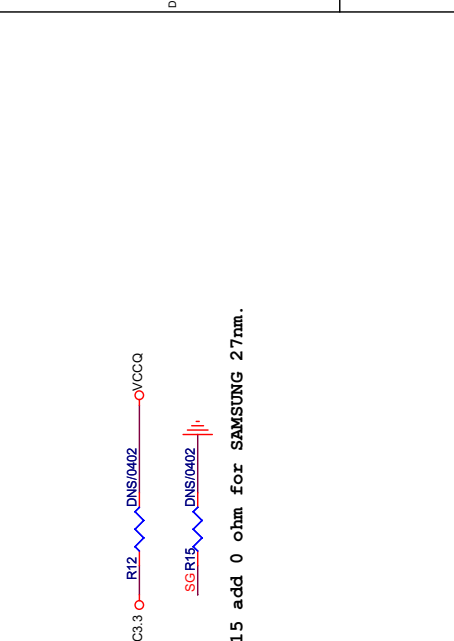

R12, R15 add 0 ohm for SAMSUNG 27nm.

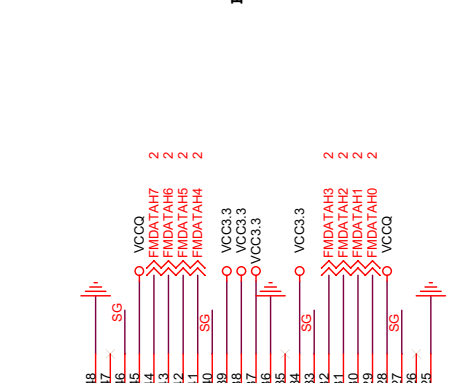

R12, R15 add 0 ohm for SAMSUNG 27nm.

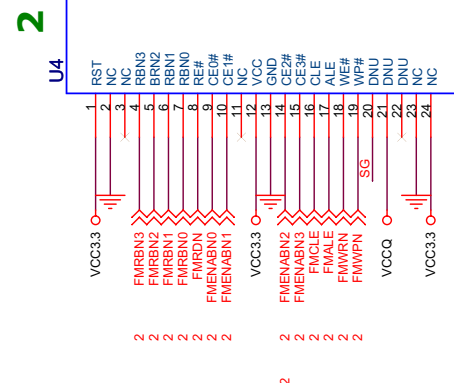

R12, R15 add 0 ohm for SAMSUNG 27nm.

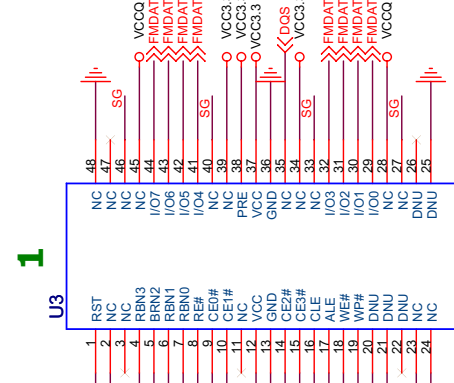

R12, R15 add 0 ohm for SAMSUNG 27nm.



R12, R15 add 0 ohm for SAMSUNG 27nm.

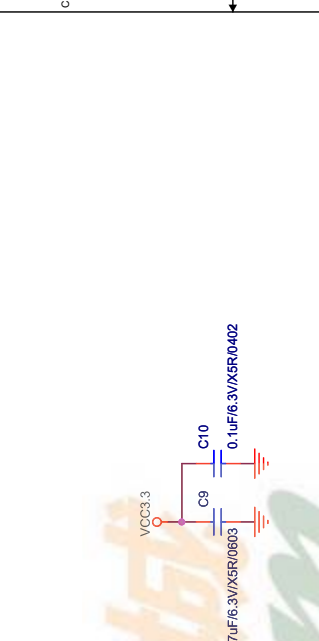

R12, R15 add 0 ohm for SAMSUNG 27nm.



R12, R15 add 0 ohm for SAMSUNG 27nm.

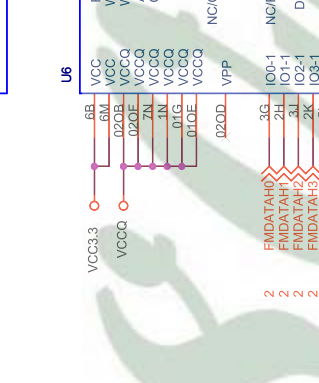

R12, R15 add 0 ohm for SAMSUNG 27nm.

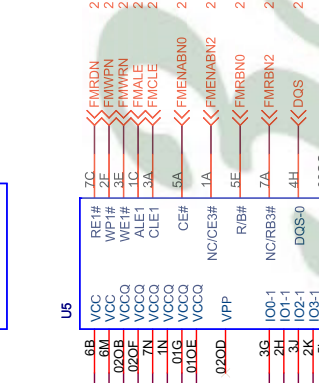

R12, R15 add 0 ohm for SAMSUNG 27nm.



R12, R15 add 0 ohm for SAMSUNG 27nm.



R12, R15 add 0 ohm for SAMSUNG 27nm.



R12, R15 add 0 ohm for SAMSUNG 27nm.

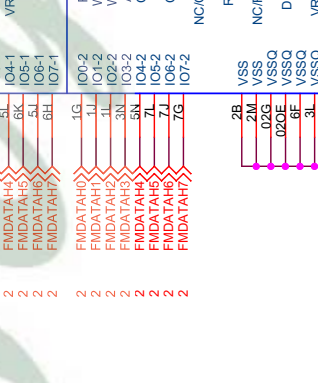

R12, R15 add 0 ohm for SAMSUNG 27nm.

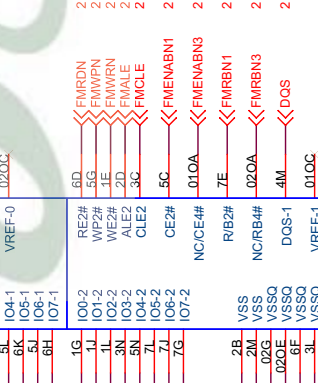

R12, R15 add 0 ohm for SAMSUNG 27nm.



R12, R15 add 0 ohm for SAMSUNG 27nm.

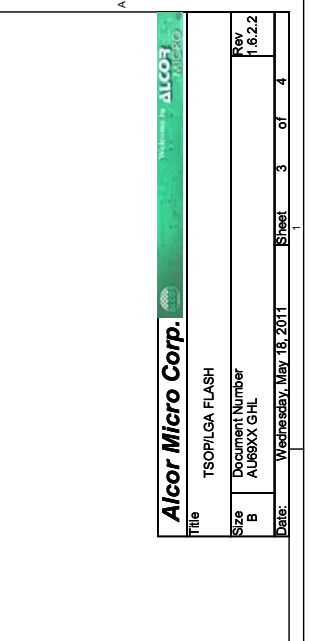

R12, R15 add 0 ohm for SAMSUNG 27nm.

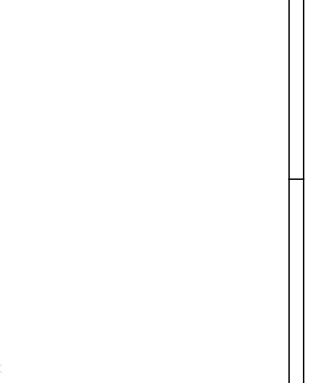

R12, R15 add 0 ohm for SAMSUNG 27nm.

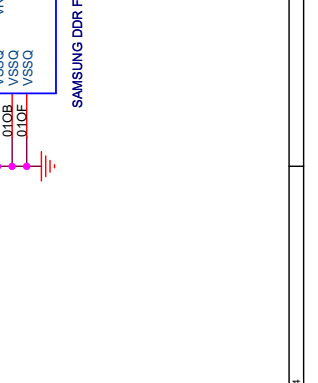

R12, R15 add 0 ohm for SAMSUNG 27nm.

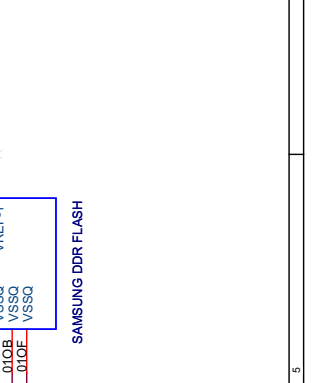

R12, R15 add 0 ohm for SAMSUNG 27nm.



R12, R15 add 0 ohm for SAMSUNG 27nm.